

Tait general software licence agreement

This legal document is an Agreement between you (the "Licensee") and Tait Electronics Limited ("Tait"). By using any of the Software or Firmware items prior-installed in the related Tait product, included on this CD or downloaded from the Tait website, (hereinafter referred to as "the Software or Firmware") you agree to be bound by the terms of this Agreement. If you do not agree to the terms of this Agreement, do not install and use any of the Software or Firmware. If you install and use any of the Software or Firmware that will be deemed to be acceptance of the terms of this licence agreement.

The terms of this agreement shall apply subject only to any express written terms of agreement to the contrary between Tait and the Licensee.

Licence

TAIT GRANTS TO YOU AS LICENSEE THE NON-EXCLUSIVE RIGHT TO USE THE SOFTWARE OR FIRMWARE ON A SINGLE MACHINE PROVIDED YOU MAY ONLY:

1. COPY THE SOFTWARE OR FIRMWARE INTO ANY MACHINE READABLE OR PRINTED FORM FOR BACKUP PURPOSES IN SUPPORT OF YOUR USE OF THE PROGRAM ON THE SINGLE MACHINE (CERTAIN PROGRAMS, HOWEVER, MAY INCLUDE MECHANISMS TO LIMIT OR INHIBIT COPYING, THEY ARE MARKED "COPY PROTECTED"), PROVIDED THE COPYRIGHT NOTICE MUST BE REPRODUCED AND INCLUDED ON ANY SUCH COPY OF THE SOFTWARE OR FIRMWARE; AND / OR
2. MERGE IT INTO ANOTHER PROGRAM FOR YOUR USE ON THE SINGLE MACHINE (ANY PORTION OF ANY SOFTWARE OR FIRMWARE

MERGED INTO ANOTHER PROGRAM WILL CONTINUE TO BE SUBJECT TO THE TERMS AND CONDITIONS OF THIS AGREEMENT).

THE LICENSEE MAY NOT DUPLICATE, MODIFY, REVERSE COMPILE OR REVERSE ASSEMBLE ANY SOFTWARE OR FIRMWARE IN WHOLE OR PART.

Title to Software

THIS AGREEMENT DOES NOT CONSTITUTE A CONTRACT OF SALE IN RELATION TO THE SOFTWARE OR FIRMWARE SUPPLIED TO THE LICENSEE. NOT WITHSTANDING THE LICENSEE MAY OWN THE MAGNETIC OR OTHER PHYSICAL MEDIA ON WHICH THE SOFTWARE OR FIRMWARE WAS ORIGINALLY SUPPLIED, OR HAS SUBSEQUENTLY BEEN RECORDED OR FIXED, IT IS A FUNDAMENTAL TERM OF THIS AGREEMENT THAT AT ALL TIMES TITLE AND OWNERSHIP OF THE SOFTWARE OR FIRMWARE, WHETHER ON THE ORIGINAL MEDIA OR OTHERWISE, SHALL REMAIN VESTED IN TAIT OR THIRD PARTIES WHO HAVE GRANTED LICENCES TO TAIT.

Term and Termination

THIS LICENCE SHALL BE EFFECTIVE UNTIL TERMINATED IN ACCORDANCE WITH THE PROVISIONS OF THIS AGREEMENT. THE LICENSEE MAY TERMINATE THIS LICENCE AT ANY TIME BY DESTROYING ALL COPIES OF THE SOFTWARE OR FIRMWARE AND ASSOCIATED WRITTEN MATERIALS. THIS LICENCE WILL BE TERMINATED AUTOMATICALLY AND WITHOUT NOTICE FROM TAIT IN THE EVENT THAT THE LICENSEE FAILS TO COMPLY WITH ANY TERM OR CONDITION OF THIS AGREEMENT. THE LICENSEE AGREES TO DESTROY ALL COPIES OF THE SOFTWARE OR FIRMWARE AND ASSOCIATED WRITTEN MATERIALS IN THE EVENT OF SUCH TERMINATION.

Limited Warranty

THE SOFTWARE OR FIRMWARE IS SUPPLIED BY TAIT AND ACCEPTED BY THE LICENSEE "AS IS" WITHOUT WARRANTY OF ANY KIND EITHER EXPRESSED OR IMPLIED, INCLUDING BUT NOT BEING LIMITED TO ANY IMPLIED WARRANTIES AS TO MERCHANTABILITY OR FITNESS FOR ANY PARTICULAR PURPOSE. THE LICENSEE ACKNOWLEDGES THAT THE SOFTWARE OR FIRMWARE IS USED BY IT IN BUSINESS AND ACCORDINGLY TO THE MAXIMUM EXTENT PERMITTED BY LAW NO TERMS OR WARRANTIES WHICH ARE IMPLIED BY LEGISLATION SHALL APPLY TO THIS AGREEMENT. TAIT DOES NOT WARRANT THAT THE FUNCTIONS CONTAINED IN THE SOFTWARE OR FIRMWARE WILL MEET THE LICENSEE'S REQUIREMENTS OR THAT THE OPERATION OF THE SOFTWARE OR FIRMWARE WILL BE UNINTERRUPTED OR ERROR FREE.

Exclusion of Liability

TAIT'S ENTIRE LIABILITY AND THE LICENSEE'S EXCLUSIVE REMEDY SHALL BE THE FOLLOWING:

1. IN NO CIRCUMSTANCES SHALL TAIT BE UNDER ANY LIABILITY TO THE LICENSEE, OR ANY OTHER PERSON WHATSOEVER, FOR ANY DIRECT OR CONSEQUENTIAL DAMAGE ARISING OUT OF OR IN CONNECTION WITH ANY USE OR INABILITY OF USING THE SOFTWARE OR FIRMWARE.
2. TAIT WARRANTS THE OPERATION OF THE SOFTWARE OR FIRMWARE ONLY WITH THE OPERATING SYSTEM FOR WHICH IT WAS DESIGNED. USE OF THE SOFTWARE OR FIRMWARE WITH AN OPERATING SYSTEM OTHER THAN THAT FOR WHICH IT WAS DESIGNED MAY NOT BE SUPPORTED BY TAIT, UNLESS OTHERWISE EXPRESSLY AGREED BY TAIT.

General

THE LICENSEE CONFIRMS THAT IT SHALL COMPLY WITH THE PROVISIONS OF LAW IN RELATION TO THE SOFTWARE OR FIRMWARE.

Law and Jurisdiction

THIS AGREEMENT SHALL BE SUBJECT TO AND CONSTRUED IN ACCORDANCE WITH NEW ZEALAND LAW AND DISPUTES BETWEEN THE PARTIES CONCERNING THE PROVISIONS HEREOF SHALL BE DETERMINED BY THE NEW ZEALAND COURTS OF LAW. PROVIDED HOWEVER TAIT MAY AT ITS ELECTION BRING PROCEEDINGS FOR BREACH OF THE TERMS HEREOF OR FOR THE ENFORCEMENT OF ANY JUDGEMENT IN RELATION TO A BREACH OF THE TERMS HEREOF IN ANY JURISDICTION TAIT CONSIDERS FIT FOR THE PURPOSE OF ENSURING COMPLIANCE WITH THE TERMS HEREOF OR OBTAINING RELIEF FOR BREACH OF THE TERMS HEREOF.

No Dealings

THE LICENSEE MAY NOT SUBLICENSE, ASSIGN OR TRANSFER THE LICENCE OR THE PROGRAM EXCEPT AS EXPRESSLY PROVIDED IN THIS AGREEMENT. ANY ATTEMPT OTHERWISE TO SUBLICENSE, ASSIGN OR TRANSFER ANY OF THE RIGHTS, DUTIES OR OBLIGATIONS HEREUNDER IS VOID.

No Other Terms

THE LICENSEE ACKNOWLEDGES THAT IT HAS READ THIS AGREEMENT, UNDERSTANDS IT AND AGREES TO BE BOUND BY ITS TERMS AND CONDITIONS. THE LICENSEE FURTHER AGREES THAT SUBJECT ONLY TO ANY EXPRESS WRITTEN TERMS OF AGREEMENT TO THE CONTRARY BETWEEN TAIT AND THE LICENSEE THIS IS THE COMPLETE AND EXCLUSIVE STATEMENT OF THE AGREEMENT BETWEEN IT AND TAIT IN RELATION TO THE SOFTWARE OR FIRMWARE WHICH SUPERSEDES ANY PROPOSAL OR PRIOR AGREEMENT, ORAL OR WRITTEN AND ANY OTHER COMMUNICATIONS BETWEEN THE LICENSEE AND TAIT RELATING TO THE SOFTWARE OR FIRMWARE.

About this guide

This user's guide provides information about the TM8250 and TM8255 mobile radios and is divided into two parts.

- Part A explains how the TM8255 radio operates. The TM8250 radio has a control head without user controls, so no TM8250 operating information is needed.
- Part B outlines the installation procedure for both TM8250 and TM8255 radios and describes the pin allocations of the two programming connectors on the TM8250 control head.

Important safety information

This user's guide also contains important safety information about using and installing TM8250 and TM8255 radios. Refer to page 11 for user safety and compliance instructions and page 30 for installation safety instructions.

Alert notices

Within this guide, four types of alerts are given to the reader: warning, caution, important and note. The following paragraphs illustrate each type of alert and its associated symbol.



Warning: There is a potential risk of death or serious injury.



Caution: There is the risk of minor or moderate injury to people.



Important: There is a risk of equipment damage or malfunction.



Note: This highlights information that is required to ensure that procedures are performed correctly.

Updating this guide

In the interests of improving the performance, reliability or servicing of the equipment, Tait Electronics Ltd reserves the right to update both the equipment or this user's guide, without prior notice.

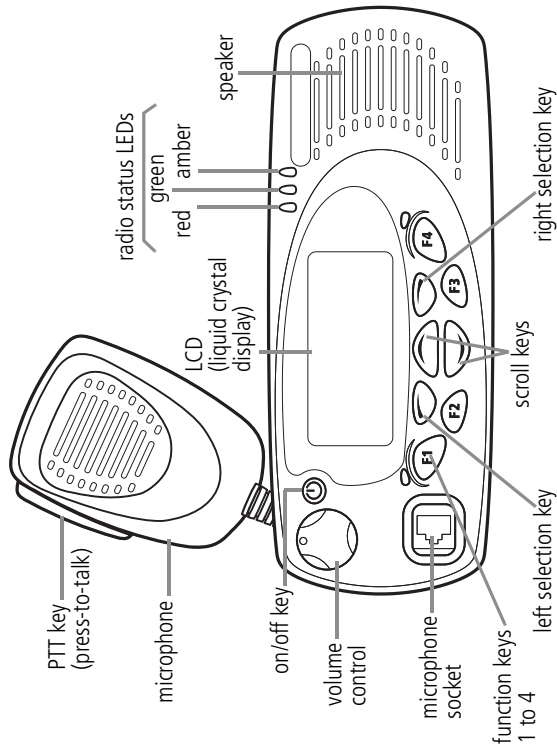



Navigating your radio's menus

Main menu: conventional mode



Note: Only menus associated with features programmed on your radio will be available.

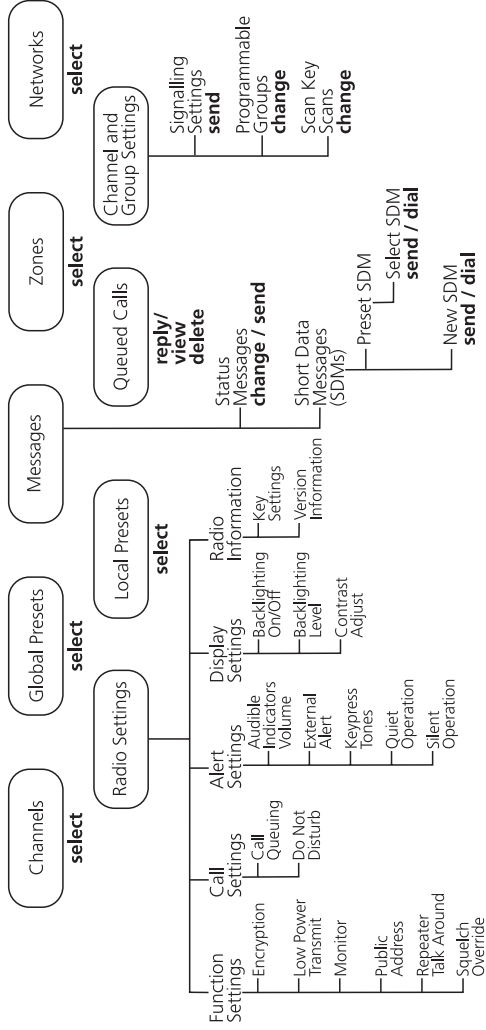

Part 1: Radio operation

Tait general software licence agreement	1
About this guide	3
Important safety information	3
Alert notices	3
Updating this guide	3
Your radio's settings	5
Navigating your radio's menus	7
Safety and compliance warnings	11
Radio frequency exposure information	11
Using this radio	11
Controlling your exposure to RF energy	11
Compliance with RF energy exposure standards	12
Warning: Safe radio operation	13
Caution: EN 60950 requirements	13
Caution: High temperatures	13
Important: Radio protection	13
Getting started	14
Radio controls	14
Radio indicators	16
Radio display	16
Radio display icons	17
LED indicators	18
Audible tones	18
Basic operation	19
Turning the radio on and off	19
Entering your PIN	19
Adjusting the speaker volume	19
Using the radio menu	19
Quick access menu	20
Selecting a channel or group	20
Making a call	20
Making a call on a conventional network	20
Making a call on an MPT trunked network	21
Transmit timer	21
Receiving a call	21

Changing networks	22
What you hear on a channel	22
Signalling mute	23
Squelch	23
Checking that a channel is clear	23
Activating monitor using the monitor function key	23
Activating monitor using the menu	24
Troubleshooting	25
When your radio won't turn on	25
Removing the radio from the vehicle	25
Audible tones	26
Notes	28

Safety and compliance warnings

Radio frequency exposure information

For your own safety and to ensure you comply with the Federal Communication Commission's (FCC) radio frequency (RF) exposure guidelines, please read the following information before using this radio.

Using this radio

You should use this radio only for work-related purposes (it is not authorized for any other use) and if you are fully aware of, and can exercise control over, your exposure to RF energy. To prevent exceeding FCC RF exposure limits, you must control the amount and duration of RF that you and other people are exposed to.

It is also important that you:

- Do not remove the RF Exposure label from the radio.
- Ensure this RF exposure information accompanies the radio when it is transferred to other users.
- Do not use the radio if you do not adhere to the guidelines on controlling your exposure to RF.

Controlling your exposure to RF energy

This radio emits radio frequency (RF) energy or radio waves primarily when calls are received and made. RF is a form of electromagnetic energy (as is sunlight), and there are recommended levels of maximum RF exposure.

To control your exposure to RF and comply with the maximum exposure limits for occupational/controlled environments, follow these guidelines:

- Do not talk (transmit) on the radio more than the rated transmit duty cycle. This is important because the radio radiates more energy when it is transmitting than when it is receiving.

- While you are transmitting (talking or sending data) on the radio, you must ensure that there is always a distance of 0.9m (35 inches) between people and the antenna. This is the minimum safe distance.
- Use the radio only with Tait-approved antennas and attachments, and make only authorized modifications to the antenna otherwise you could damage the radio and violate FCC regulations.

For more information on what RF energy is and how to control your exposure to it, visit the FCC website at <http://www.fcc.gov/oet/rfsafety/rf-faqs.html>.

Compliance with RF energy exposure standards

This two-way radio complies with these RF energy exposure standards and guidelines:

- United States Federal Communications Commission, Code of Federal Regulations; 47 CFR part 2 subpart J
- American National Standards Institute (ANSI) / Institute of Electrical and Electronic Engineers (IEEE) C95. 1-1992
- Institute of Electrical and Electronic Engineers (IEEE) C95.1-1999 Edition.

This radio complies with the IEEE (FCC) and ICNIRP exposure limits for occupational/controlled RF exposure environments at operating duty factors of up to 50% talk to 50% listen.



Warning: Safe radio operation

- Switch the radio off at petrol filling stations or near flammable liquids or gases.
- Switch the radio off in the vicinity of explosive devices and blasting zones.
- Using a handheld microphone or a radio while driving a vehicle may violate the laws and legislation that apply in your country or state. Please check the vehicle regulations in your area.



Caution: EN 60950 requirements

This radio complies with the European Union standard EN 60950 when operated up to the rated 33% duty cycle of two minutes transmit and four minutes receive, and with ambient temperatures of 30°C or lower.

Operation outside these limits may cause the external temperature of the radio to rise higher than this standard permits.



Caution: High temperatures

The bottom surface of the radio and the heatsink fins can become hot during prolonged operation. Do not touch these parts of the radio.



Important: Radio protection

Always remove the fuses from the radio power cable before charging the vehicle battery, connecting a second battery or using power from another vehicle (e.g. when "jump-starting" the vehicle).

Getting started

This section provides a brief description of your radio's basic operation. If you need further information, contact your radio provider.







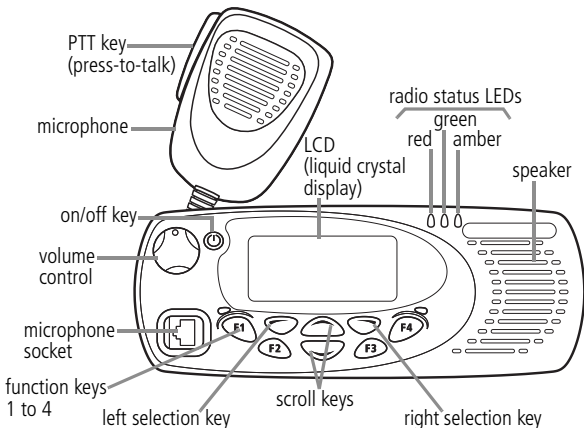

Radio controls

The radio controls are the PTT key, volume control, on/off key, scroll keys, selection keys and function keys. Some keys may have functions assigned to both short and long key presses:

- a short key press is defined as less than one second, and
- a long key press is more than one second.

The radio controls and their functions are summarized in the diagram and table on the following page.



Symbol	Name	Function
	PTT	press and hold to transmit and release to listen MPT mode: initiates a call from the idle state
	volume control	rotate to change the speaker volume
	power key	turn the radio on or off with a long press
	left selection key	action determined by the text above the left selection key
	right selection key	action determined by the text above the right selection key
	scroll keys	scroll up and down through a list of menu options or scroll left and right in messages, or access the lists of channels or preset calls
	function keys 1, 2, 3 and 4	function keys with programmed options
		
		
		

Radio indicators

The radio display, LED indicators and the radio's audible tones all combine to give you information about the state of your radio.

The most common operation of the radio display and indicators is described in the following sections.

 Note: The way these indicators behave may be affected by the way your radio is programmed.







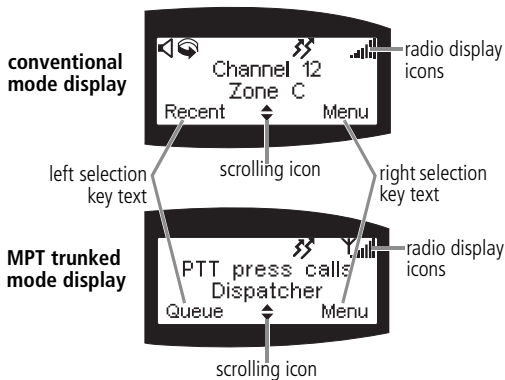



Radio display

The messages and icons you see in your radio display depends upon the mode in which your radio is operating. Also, your radio may be programmed to display programmed information on start-up, such as your network identity.

The following diagrams show two typical displays, one of a radio operating in conventional mode and the other in MPT trunked mode.



Radio display icons

Icon	Meaning
	RSSI (received signal strength indicator): the more bars on the indicator, the stronger the signal being received by your radio.
	MPT network available: your radio has access to an MPT network flashing: your radio is attempting to access an MPT network
	transmit: your radio is transmitting
	low-power transmit: your radio is transmitting on low-power
	scanning: your radio is monitoring a group of channels for activity
	monitor or squelch override: monitor or squelch override is active
	quiet mode: you are in quiet mode and your radio keypress tones and confidence tones have been turned off
	scrolling: you can use the scroll keys  or  to move through a list

LED indicators

LED	Meaning
red	glowing: your radio is transmitting
(transmit)	flashing: your transmit timer is about to expire
green	glowing: you are receiving
(receive)	flashing: you have received a call
amber	glowing: your radio is scanning a group of channels for activity (conventional mode) or network service is available (MPT trunked mode)
(scanning or network)	flashing: your radio has detected activity on a channel, and has halted on this channel (conventional mode)
	flashing fast: in trunked mode, there is no network service available

Audible tones



Note: If quiet or silent mode has been turned on, you will not hear any audible tones.

Refer to page 26 for a description of other tones you may hear.

Tone type	Meaning
two short beeps	radio turned on: the radio is powered on and ready to use
one short beep	radio turned off: the radio is powered off
one short beep	valid keypress: the action you have attempted is permitted
one long, low-pitched beep	invalid keypress: the action you have attempted is not permitted
one long, low-pitched beep	transmission inhibited: you have attempted to transmit but for some reason transmission is not permitted at this time

Basic operation

This section describes the basic operation of your radio, including turning the radio on and off and adjusting the volume.

Turning the radio on and off

A long press of the on/off key  turns the radio either on or off. When the radio is first turned on, the red, green and amber LEDs flash briefly and the radio gives two short beeps.

Entering your PIN

You may need to enter a PIN (personal identification number) before you can use your radio. If the message **radio locked enter pin** is displayed, enter your assigned PIN.

Once you have entered you PIN correctly, the **pin accepted** message appears and normal operation is now possible.



If you do not know your PIN or you receive the **incorrect pin** message after entering your PIN, consult your radio provider.

Adjusting the speaker volume

Rotate the volume control clockwise to increase the speaker volume and counterclockwise to decrease the volume. The volume control also changes the volume level of the radio's audible indicators.

Using the radio menu



Whenever **Menu** appears above the right selection key, press the right selection key to enter the main menu.

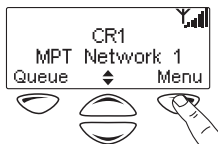

Use the scroll keys  or  to move through the list of menus.

When the menu you want is highlighted, press **Select** using the right selection key  and the menu you have chosen is displayed.





Quick access menu

A menu that is used frequently may be programmed as your quick access menu. To go to your quick access menu, press a scroll key  or , and the menu is displayed.

For example, if your channels menu is your quick access menu, press a scroll key  or  to go directly to the channels menu.

Selecting a channel or group

To select a channel or group you can either:

- use the scroll keys  or  to scroll through the channel list until the channel or group you want is displayed, or
- use the menu (see “Using the radio menu” on page 19).

Making a call

The network that your radio is operating on determines the way you make a call. The two network options that affect the calling procedure are:

- conventional, and
- MPT trunked.

Making a call on a conventional network

1. Select the required channel, group or zone.
2. Check the green LED.
If the green LED is glowing, the channel is busy and you cannot transmit.
3. Once the channel is clear (the green LED is off), lift the microphone off the microphone clip.
4. Hold the microphone about 5 cm (2 inches) from your mouth and press the PTT key to transmit.

5. Speak clearly into the microphone and release the PTT key when you have finished talking.



Note: You cannot change channels while transmitting.

Making a call on an MPT trunked network

1. Select the required channel, and press the PTT key.
2. Once the person you have called replies, lift the microphone off the microphone clip.
3. Hold the microphone about 5 cm (2 inches) from your mouth and press the PTT key to transmit.
4. Speak clearly into the microphone and release the PTT key when you have finished talking.

Transmit timer

Your radio may have a transmit timer that limits the amount of time you can transmit continuously. When the transmit timer is about to expire, the red LED flashes and the radio gives three beeps. You must release the PTT before you can transmit again.



Note: Your radio may be unable to transmit for a short time after the transmit timer has expired.

Receiving a call

When there is valid activity on your radio's currently selected channel or group, the radio then unmutes and you can hear the call.

If the incoming call contains special signalling that matches the signalling programmed for your radio, the green LED flashes and your radio may give a ringing tone.

Changing networks

1. Press **Menu** and scroll through the list of menu items until **Networks** is displayed.

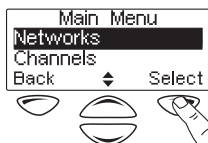

2. Press **Select** to enter the Network Menu and the current network is highlighted.

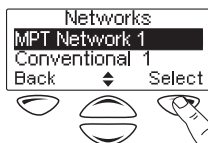

3. Scroll down the list until the required network option is displayed, and press **Select**.

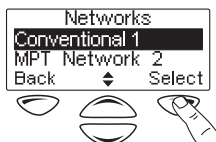

4. Press **Yes** when you are prompted to confirm your selection.

What you hear on a channel

Your radio may be programmed so that you hear all conversations on a channel, or your user group may be segregated from other user groups by using special signalling. The special signalling is used to control the muting and unmuting of your radio, so that your radio is muted when other user groups are talking and unmuted for members of your user group.

The two muting controls that operate in your radio are:

- signalling mute, and
- squelch.

Signalling mute

The radio's signalling mute only allows the radio to unmute if the incoming call carries the tones specific to your user group. Your user group may use tones that are either audible, subaudible or both.

Squelch

The radio's squelch allows the radio to unmute only when the strength of the incoming signal is above a predetermined threshold. This means that only signals of reasonable intelligibility are made audible.

Checking that a channel is clear

Use the monitor function to check that the channel is clear before you make a call. While monitor is on, the green LED flashes continually and the monitor icon  is displayed.

To activate monitor, you can either:

- use a function key that may have been programmed for monitor, or
- use the menu.

Activating monitor using the monitor function key

1. Press the monitor function key and monitor overrides the signalling mute, allowing you to hear any traffic on the channel.



Note: Your radio may be programmed to activate monitor whenever the microphone is off the microphone clip.

2. Press the monitor function key again to turn monitor off.

Activating monitor using the menu

1. Press **Menu**, and scroll through the list of menu items until **Function Settings** is displayed.

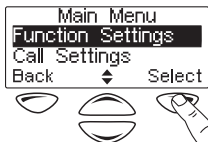

2. Press **Select** to enter the function settings menu, then scroll down the list of menu items until **Monitor** is displayed.

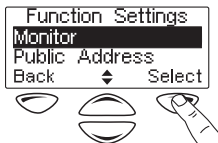

3. Press **Select** to select monitor, then **Select** to select **On**.

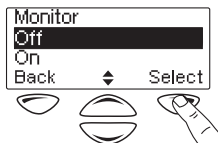

Troubleshooting

When your radio won't turn on

If the red, green and amber LEDs on the control head do not light up when the radio is turned on, it is likely that no power is reaching the radio. Check the following:

- Is the power connector firmly plugged into the rear of the radio?
- Are the in-line fuses in good condition?
- Is the power cable securely connected to the vehicle battery or power supply?

If all appears to be in order, then contact your radio provider for further assistance.

Removing the radio from the vehicle

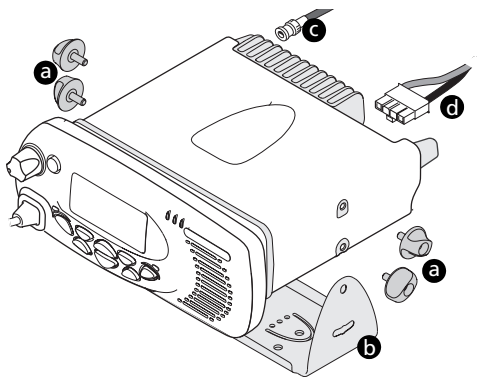

1. Switch off the radio.
2. Unscrew the four thumb screws **a** that secure the radio to the U-bracket **b**.
3. Lift the radio clear of the U-bracket.
4. Disconnect the antenna **c** and power cable **d** from the rear of the radio.

Audible tones

The following table gives a list of the radio's audible tones, additional to those explained on page 18.

Action and tone	Meaning
one short beep after the power-up beeps	radio locked: you need to enter your PIN (personal identity number) before you can use the radio
one long, low-pitched beep	radio PIN entry unsuccessful: you need to re-enter your PIN
two short beeps	radio PIN entry successful: the radio is ready to use
one short beep	function activated: a function key has been pressed and that function has been initiated
one short, low-pitched beep	function de-activated: a function key has been pressed and the corresponding function has been turned off
one long, low-pitched beep	transmission inhibited: you have attempted to transmit but for some reason transmission is not permitted at this time
one short, high-pitched beep	radio is stunned: the radio has been made inoperable by your service provider
two short beeps	radio is revived: the radio has made operable by your service provider
three beeps	transmit timeout imminent: in 10 seconds your transmit timer will expire and your current transmission will be terminated
two low-pitched beeps	radio's temperature is high: the radio's temperature is in the high-temperature range, but the radio will continue to operate

Action and tone	Meaning
two high-pitched beeps	radio's temperature is very high: the radio's temperature is in the very high temperature range and all transmissions will now be at low power; if the radio's temperature rises outside this range, transmissions will be inhibited
continuous low-pitched tone	radio system error: a system error has occurred and the radio may be inoperable. (the LCD usually displays either E1 or E2)
two long low-high pitched tone pairs	synthesizer is out-of-lock: the radio's synthesizer is out-of-lock on the current channel and you cannot operate on that channel (LCD will usually be flashing OL)

Notes

Part 2: Radio installation procedures

Installation warnings	30
Warning: Safe radio mounting	30
Warning: Interference with vehicular electronics	30
Warning: Liquefied petroleum gas powered vehicles	30
Important: Non-standard radio installations	31
Important: Negative ground supply	31
Installation planning	32
MPT 1362 code of practice	32
Checking equipment	32
Installation tools	32
Microphone clip installation tools (TM8255 only)	33
Mounting position	33
Radio Installation	34
Mounting the U-bracket	34
Control head handling precautions	34
Installing the control head on the radio body	34
Removing the control head	35
Installing the microphone	36
Installing the antenna	36
Warning: RF exposure hazard	36
Antenna termination	37
Power cable	37
Installing the power cable	37
Installing the radio in the U-bracket	38
Microphone clip (TM8255 radios only)	39
TM8250 connectors	39
Installation checks	40
Other installation options	40

Installation warnings



Warning: Safe radio mounting

- Mount the radio securely so that it will not break loose in the event of a collision. An unsecured radio is dangerous to the vehicle occupants.
- Mount the radio where it will not interfere with the deployment of passenger air bags.
- Do not mount the radio vertically, with the control head facing down. This will violate compliance with the European Union standard EN 60950, Safety of Information Technology Equipment.



Warning: Interference with vehicular electronics

Some vehicular electronic devices may be prone to malfunction, due to the lack of protection from RF energy present when your radio is transmitting.

Examples of vehicular electronic devices that may be affected by RF energy are:

- electronic fuel injection systems
- electronic anti-skid braking systems
- electronic cruise control systems.

If the vehicle contains such equipment, consult the vehicle manufacturer or dealer in order to determine whether these electronic circuits will perform normally when the radio is transmitting.



Warning: Liquefied petroleum gas powered vehicles

Radio installation in vehicles powered by LP (liquefied petroleum) gas with the LP gas container in a sealed-off space within the interior of the vehicle must conform to the National Fire Protection Association Standard NFPA 58. This standard states that the radio equipment installation must meet the following requirements.

- The space containing the radio equipment shall be isolated by a seal from the space containing the LP gas container and its fitting.
- Outside filling connections shall be used for the LP gas container and its fittings.
- The LP gas container space shall be vented to the outside of the vehicle.



Important: Non-standard radio installations

The installation U-bracket described in this guide has been designed so that there is enough airflow around the radio to provide cooling.

If a non-standard installation method is used, care must be taken that sufficient heat can be dissipated from the radio heatsink fins and the bottom surface of the radio chassis.

For this to be achieved, there must be a gap of more than 10mm (0.4 inch) between the bottom surface of the radio chassis and the mounting surface. This is illustrated in the following diagram.

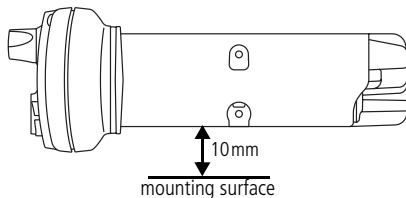

Important: Negative ground supply

TM8200 radios are designed to operate only in a negative ground system.

Installation planning

The procedures outlined in this and the following sections are for installing a TM8250 or TM8255 radio in a vehicle, using a standard U-bracket.

MPT 1362 code of practice

TM8200 radios should be installed in accordance with the MPT 1362 Code of Practice. This code of practice covers the installation of mobile radio equipment in land based vehicles and has been developed by the United Kingdom Radiocommunications Agency.

The full text of the MPT 1362 Code of Practice can be found at the Radiocommunications Agency website, www.radio.gov.uk.

Checking equipment

Unpack the radio and check that you have the following items:

- radio control head with connecting loom
- radio body
- microphone with microphone clip and screws (TM8255 only)
- installation kit, consisting of:
 - U-bracket with screws
 - power cable with DC connector
 - 10A fuses
 - fuse holders
 - BNC antenna plug.

Installation tools

The following installation tools may be required:

- portable drill
- 8mm (0.3 inch) socket
- BNC crimp tool

- in-line RF power meter capable of measuring forward and reflected power at the operating frequency of the radio.

Microphone clip installation tools (TM8255 only)

The following installation tools may be required for installing the TM8255 microphone:

- centre punch
- drill bit
- Pozidriv screwdriver
- hammer.

Mounting position

Inspect the vehicle and determine the safest and most convenient location for mounting the radio.

The installation must meet the following requirements:

- sufficient clearance behind the radio for the heatsink and cables
- a large enough flat surface so that the mounting bracket will not be distorted
- no danger of the radio interfering with air bag deployment.

Radio Installation

Mounting the U-bracket

Screw the U-bracket in the chosen mounting position using the self-tapping screws provided. At least four screws must be installed. If the U-bracket is being mounted over a curved surface, bend the U-bracket tabs slightly.



Important: Check that the U-bracket is not distorted when the screws are tightened.

Control head handling precautions



Important: The control head contains devices which can be damaged by static discharges. Always install or remove the control head in a static-safe environment.

Information on antistatic precautions can be found at the Electrostatic Discharge Association (ESD) website, www.esda.org.

Installing the control head on the radio body

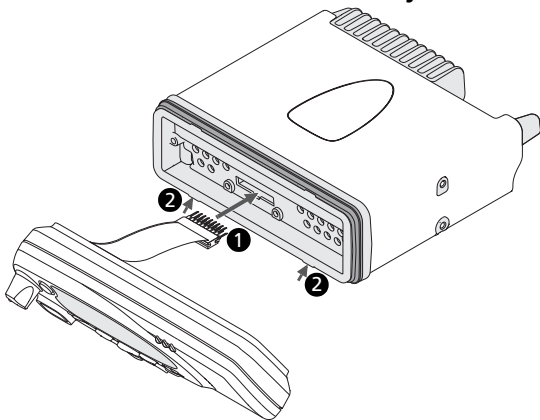

The orientation of the U-bracket mounting determines which way up the control head is mounted on the radio

body. The numbers in the diagram on the previous page refer to the numbered steps below.

1. Plug the control head loom onto the control head connector.
2. Insert the bottom edge of the control head onto the two clips in the front of the radio chassis, then snap into place.

Removing the control head



Important: During this procedure, take care that the chassis seal is not damaged. Damage to this seal reduces environmental protection.

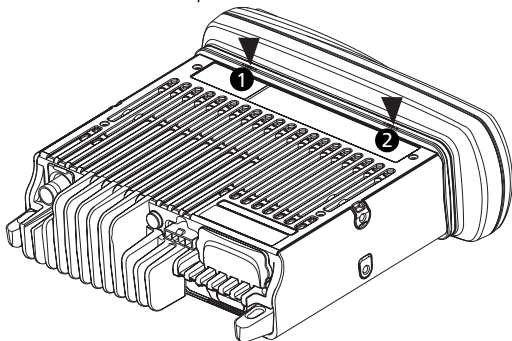

1. On the underside of the radio, insert a flat-bladed screwdriver between the control head and the radio chassis seal, in either position **1** or **2**.



Note: Insertion points **1** and **2** are indicated on the radio chassis by a dot-dash-dot pattern (•—•).

2. Use the screwdriver to lift the control head off the chassis clip, then repeat in the other position.

The control head can now be removed from the radio body.

Installing the microphone



Important: The microphone grommet must be installed whenever the microphone is plugged into the microphone socket. When installed, the grommet has two functions:

- to prevent damage to the microphone socket when there is movement of the microphone cord, and
 - to ensure that the control head is sealed against water, dust and other environmental hazards.
1. Plug the microphone into the microphone socket on the control head.
 2. Slide the microphone grommet along the microphone cord and push two adjacent corners of the grommet into the microphone socket cavity.
 3. Squeeze the grommet and push the remaining corners into position.
 4. Check that the grommet is seated correctly in the cavity.



Installing the antenna

Install the external antenna according to the supplier's instructions. Good quality 50 ohm coaxial cable must be used, such as RG58 or UR76.



Important: The cable should be routed in a manner that minimizes coupling into the electronic control systems of the vehicle.



Warning: RF exposure hazard

To comply with FCC RF exposure limits, this product must be installed using an externally mounted antenna with either a 2.15dBi or 5.15dBi gain.

This antenna must not be mounted at a location such that any person or persons can come closer than 0.9m (35 inches) to the antenna.

Antenna termination

1. Run the free end of the coaxial cable to the radio's mounting position and cut it to length, allowing 20 - 30cm (8 - 12 inches) excess.
2. Terminate the free end of the cable with the BNC plug supplied.

Power cable



Important: This radio is designed to operate from a nominal 12V negative ground supply and may draw up to 8A of current. The radio will tolerate a supply voltage range of 10.8V to 16.0V at the radio.

In vehicles with a supply voltage greater than 16.0V, such as many trucks, it is essential to provide a suitably rated DC to DC converter. This will isolate the radio from excessive battery voltage and provide the correct DC operating conditions.



Installing the power cable



Important: Disconnecting the vehicle's battery may cause problems with some electronic equipment, such as vehicle alarms, engine management systems and in-car entertainment systems. Check that the vehicle owner has the necessary information to make all electronic equipment function correctly after battery reconnection.

1. Disconnect the vehicle's battery, unless specifically prohibited from doing so by the customer, vehicle manufacturer, agent or supplier.

If the battery is not disconnected, exercise extreme caution throughout the installation and install the fuses only when the installation is ready to be checked (see "Installation checks" on page 40).

2. Determine where the power cable will be routed.
 Important: The power cable should be protected from engine heat, sharp edges and from being pinched or crushed.
3. Cut the negative and the positive wires where the in-line fuse holders will be placed (as close to the battery as possible).
 Note: Do not install the fuses until the installation is ready to be checked.
4. Insert each end of the negative wire into one of the in-line fuse holders and crimp them to force the metal contacts onto the wires.
5. Connect the negative wire to the battery ground.
6. Repeat step 4 for the positive wire and connect it to the positive terminal of the battery.

Installing the radio in the U-bracket

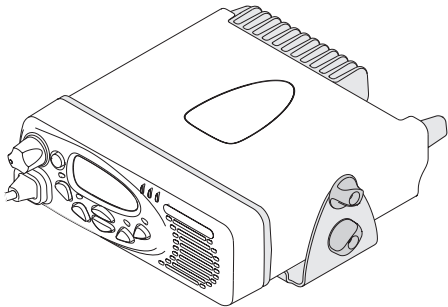

1. Connect the antenna and power cables to the rear of the radio.
2. Position the radio in the U-bracket so that the holes in the U-bracket line up with the holes in the radio chassis.
3. Screw the radio into position using the four thumb screws but without fully tightening the screws.

4. Position the radio in the U-bracket for best viewing angle, then tighten the thumb screws.

Microphone clip (TM8255 radios only)

Install the microphone clip in the most convenient location for the radio user. It must be within easy reach of the user, but in such a position that the microphone PTT key cannot be inadvertently activated or jammed on.

TM8250 connectors

The TM8250 control head has two RJ45 sockets for programming, and a power on/off LED.

 Note: The pins of the two programming connectors are connected in parallel, so care needs to be taken when connecting external devices to these connectors.

The pin allocations for these connectors are explained in the following diagram and table.

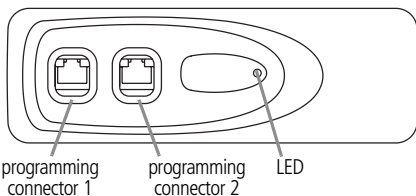

Pin	Programming connectors	Description
	ON/OFF	hardware power on/software power off
	13.8V	unswitched 13.8V power supply
	RX AUD	receive audio output
	MIC AUD	microphone audio input
	RS485-	RS485 compliant output



Pin	Programming connectors	Description
RS485+		RS485 compliant output
AGND		analogue ground
DGND		digital ground

Installation checks

1. Insert the fuses into the power leads.
2. TM8255 radios only.

Switch on the radio to confirm that it is operational (see "Turning the radio on and off" on page 19).



Important: Do not transmit yet.

3. Connect an in-line power meter between the radio and the antenna and measure the forward and reflected power levels.

Less than 4% of the forward power should be reflected. If this is not achieved, check the installation, including the antenna length.

4. TM8255 radios only.

Once the reflected power levels are within tolerance, make a call to another party on the radio (see "Selecting a channel or group" and "Making a call", on page 20).

Other installation options

Contact your radio provider for further information.